

# ISDN architecture

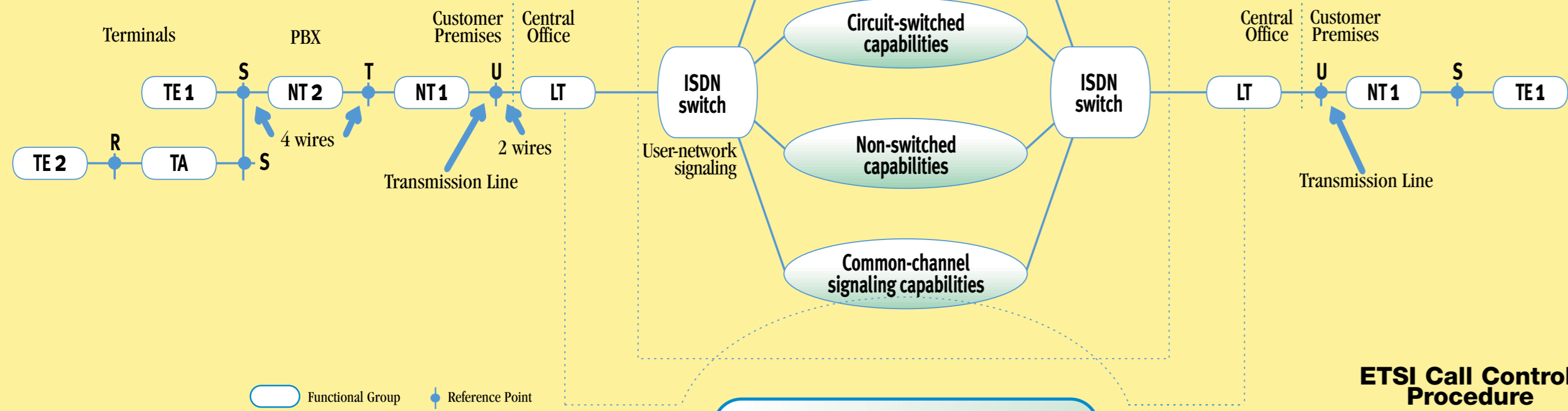

Functional Group Reference Point

## ISDN Functional Groups and Reference Points

**Line Termination (LT)**  
Network Termination 1 (NT1): handles physical layer interface functions such as line termination, power transfer and timing.  
Network Termination 2 (NT2): handles function of an NT1 plus layer 2 and layer 3 functions such as multiplexing, switching and concentration.  
**Terminal Equipment 1 (TE1)**: end-user equipment such as ISDN telephones or data terminals compliant with ISDN call set up procedures and capable of interfacing directly to the S bus.  
**Terminal Equipment 2 (TE2)**: end-user equipment for non-ISDN environments (typically uses an RS232 interface).  
**Terminal Adapter (TA)**: equipment that supports ISDN call set up and provides an interface for connecting to TE2s.

## ISDN Implementation

### OSI Model

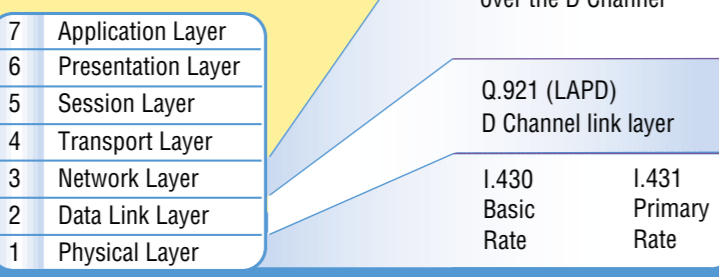

## Frame Structure at S and T Reference Points

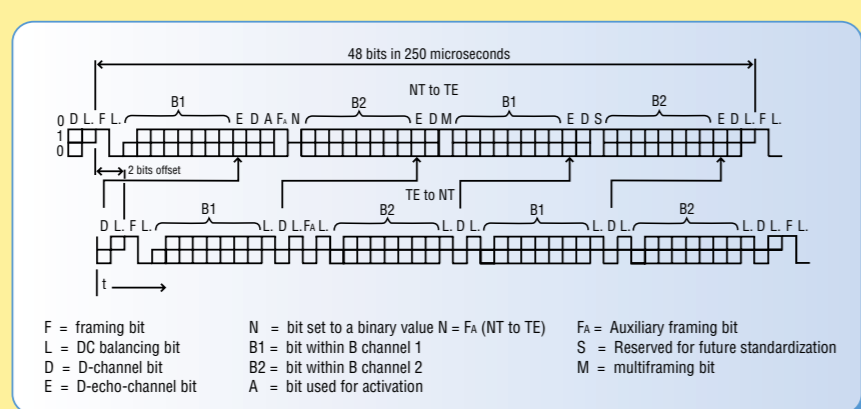

## Frame Structure at U Reference Point

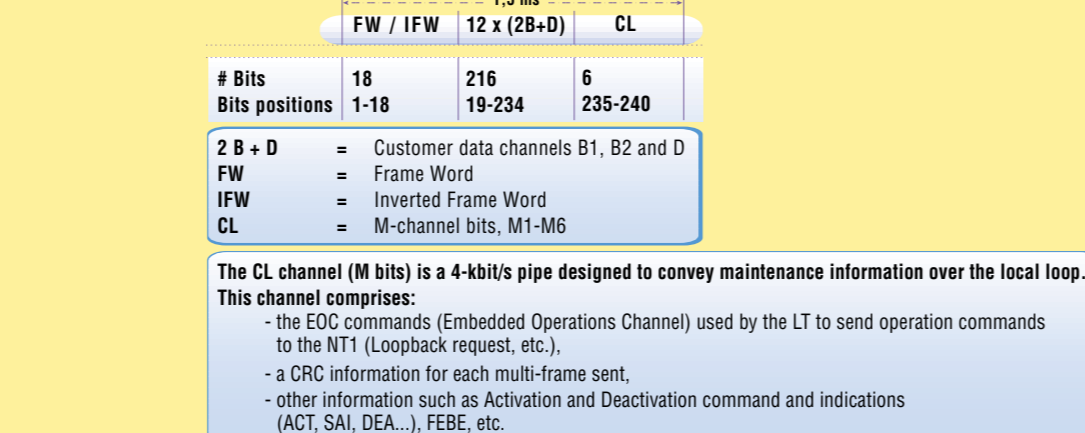

## Q.921 Address Field

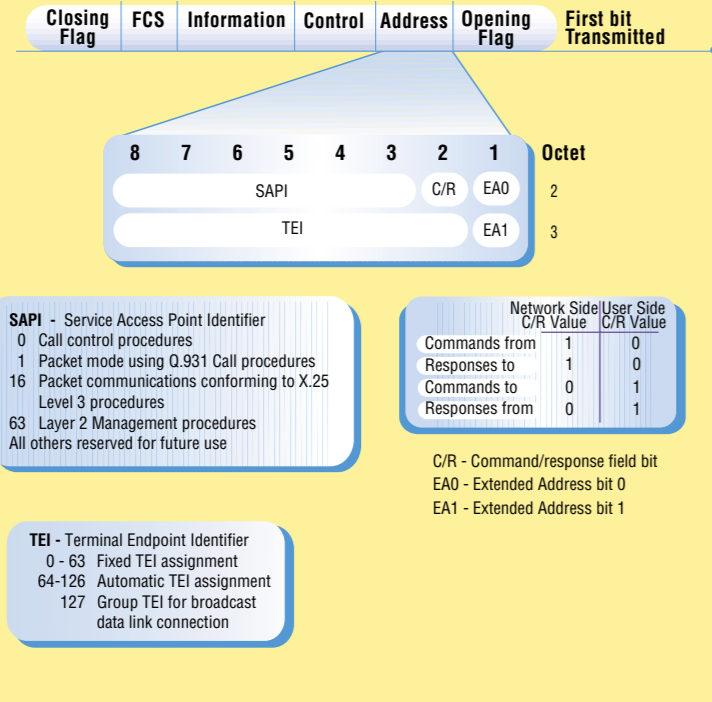

## Q.921 Control Field

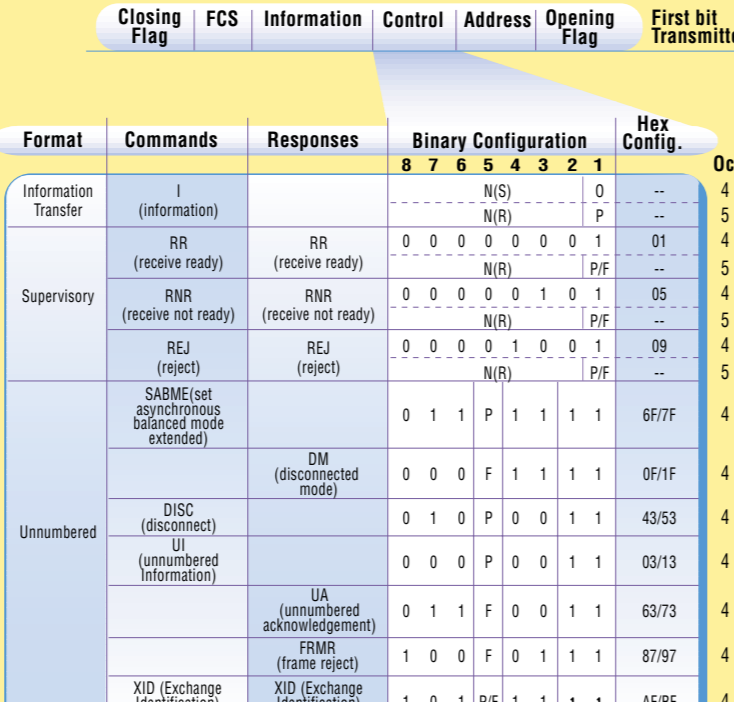

## Frame Structure for TEI Management

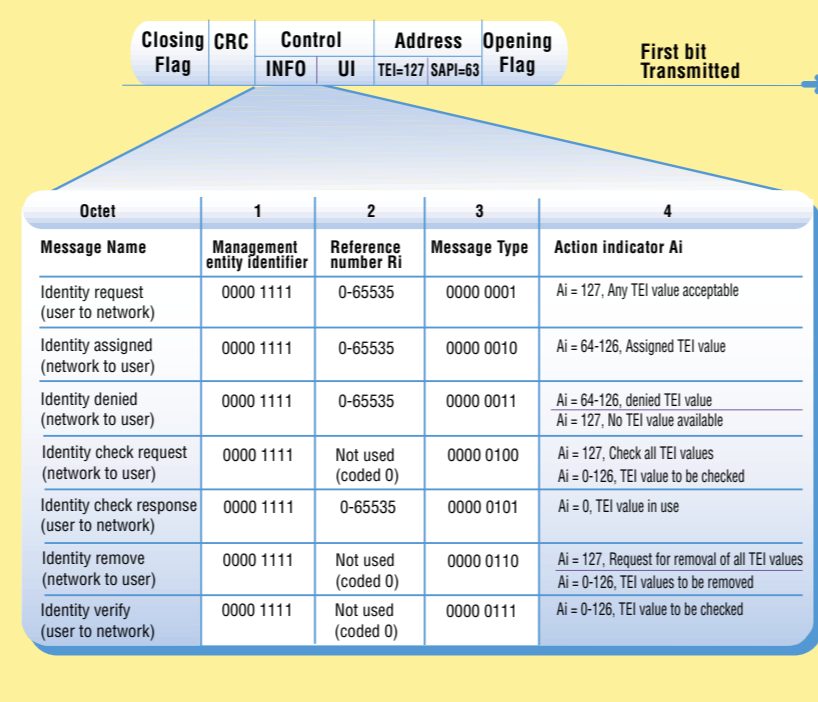

# ISDN protocols

## Layer 1

**Physical**  
Handles the physical, electrical, and procedural specifications required to transmit data across the physical medium or cables. Defines connectors, pinouts and electrical voltage and current levels. Works in units of bits.

## Layer 2

**Data link**  
Frames and Addresses Packets. Provides error-free node-to-node connections and flow control. Provides mapping between Network Layer addresses. Works in units of frames.

## Layer 3

**Network**  
Addresses, switches and routes packets between hosts. Fragments and reassembles packets. Works in units of packets.

## ETSI Message Structure

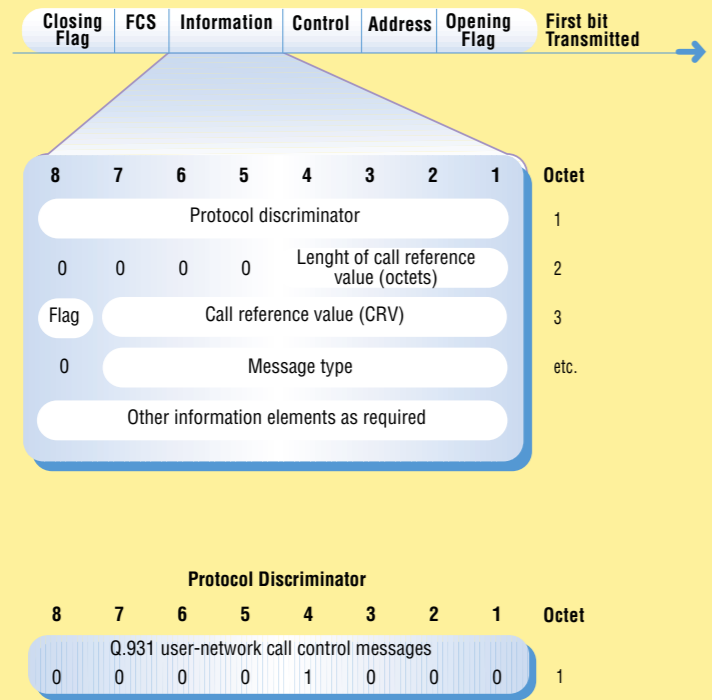

## ETSI Information Element Identifier

Hex	8	7	6	5	4	3	2	1	Information Element Identifier
0	0	0	0	0	0	0	0	0	Reserved
1	0	0	0	0	0	0	0	1	Call Setup
2	0	0	0	0	0	0	1	0	Mgmt Data
3	0	0	0	0	0	0	1	1	Setup
4	0	0	0	0	0	0	1	0	Progress
5	0	0	0	0	0	0	1	1	Call Forwarding
6	0	0	0	0	0	0	1	0	Call Transfer
7	0	0	0	0	0	0	1	1	Call Forwarding
8	0	0	0	0	0	0	1	0	Call Forwarding
9	0	0	0	0	0	0	1	1	Call Forwarding
10	0	0	0	0	0	0	1	0	Call Forwarding
11	0	0	0	0	0	0	1	1	Call Forwarding
12	0	0	0	0	0	0	1	0	Call Forwarding
13	0	0	0	0	0	0	1	1	Call Forwarding
14	0	0	0	0	0	0	1	0	Call Forwarding
15	0	0	0	0	0	0	1	1	Call Forwarding
16	0	0	0	0	0	0	1	0	Call Forwarding
17	0	0	0	0	0	0	1	1	Call Forwarding
18	0	0	0	0	0	0	1	0	Call Forwarding
19	0	0	0	0	0	0	1	1	Call Forwarding
20	0	0	0	0	0	0	1	0	Call Forwarding
21	0	0	0	0	0	0	1	1	Call Forwarding
22	0	0	0	0	0	0	1	0	Call Forwarding
23	0	0	0	0	0	0	1	1	Call Forwarding
24	0	0	0	0	0	0	1	0	Call Forwarding
25	0	0	0	0	0	0	1	1	Call Forwarding
26	0	0	0	0	0	0	1	0	Call Forwarding
27	0	0	0	0	0	0	1	1	Call Forwarding
28	0	0	0	0	0	0	1	0	Call Forwarding
29	0	0	0	0	0	0	1	1	Call Forwarding
30	0	0	0	0	0	0	1	0	Call Forwarding
31	0	0	0	0	0	0	1	1	Call Forwarding
32	0	0	0	0	0	0	1	0	Call Forwarding
33	0	0	0	0	0	0	1	1	Call Forwarding
34	0	0	0	0	0	0	1	0	Call Forwarding
35	0	0	0	0	0	0	1	1	Call Forwarding
36	0	0	0	0	0	0	1	0	Call Forwarding
37	0	0	0	0	0	0	1	1	Call Forwarding
38	0	0	0	0	0	0	1	0	Call Forwarding
39	0	0	0	0	0	0	1	1	Call Forwarding
40	0	0	0	0	0	0	1	0	Call Forwarding
41	0	0	0	0	0	0	1	1	Call Forwarding
42	0	0	0	0	0	0	1	0	Call Forwarding
43	0	0	0	0	0	0	1	1	Call Forwarding
44	0	0	0	0	0	0	1	0	Call Forwarding
45	0	0	0	0	0	0	1	1	Call Forwarding
46	0	0	0	0	0	0	1	0	Call Forwarding
47	0	0	0	0	0	0	1	1	Call Forwarding
48	0	0	0	0	0	0	1	0	Call Forwarding
49	0	0	0	0	0	0	1	1	Call Forwarding
50	0	0	0	0	0	0	1	0	Call Forwarding
51	0	0	0	0	0	0	1	1	Call Forwarding
52	0	0	0	0	0	0	1	0	Call Forwarding
53	0	0	0	0	0	0	1	1	Call Forwarding
54	0	0	0	0	0	0	1	0	Call Forwarding
55	0	0	0	0	0	0	1	1	Call Forwarding
56	0	0	0	0	0	0	1	0	Call Forwarding
57	0	0	0	0	0	0	1	1	Call Forwarding
58	0	0	0	0	0	0	1	0	Call Forwarding
59	0	0	0	0	0	0	1	1	Call Forwarding
60	0	0	0	0	0	0	1	0	Call Forwarding
61	0	0	0	0	0	0	1	1	Call Forwarding
62	0	0	0	0	0	0	1	0	Call Forwarding
63	0	0	0	0	0	0	1	1	Call Forwarding
64	0	0	0	0	0	0	1	0	Call Forwarding
65	0	0	0	0	0	0	1	1	Call Forwarding
66	0	0	0	0	0	0	1	0	Call Forwarding
67	0	0	0	0	0	0	1	1	Call Forwarding
68	0	0	0	0	0	0	1	0	Call Forwarding
69	0	0	0	0	0	0	1	1	Call Forwarding
70	0	0	0	0	0	0	1	0	Call Forwarding
71	0	0	0	0	0	0	1	1	Call Forwarding
72	0	0	0	0	0	0	1	0	Call Forwarding
73	0	0	0	0	0	0	1	1	Call Forwarding
74	0	0	0	0	0	0	1	0	Call Forwarding
75	0	0	0	0	0	0	1	1	Call Forwarding
76	0	0	0	0	0	0	1	0	Call Forwarding
77	0	0	0	0	0	0	1	1	Call Forwarding
78	0	0	0	0	0	0	1	0	Call Forwarding
79	0	0	0	0	0	0	1	1	Call Forwarding
80	0	0	0	0	0	0	1	0	Call Forwarding
81	0	0	0	0	0	0	1	1	Call Forwarding
82	0	0	0	0	0	0	1	0	Call Forwarding
83	0	0	0	0	0	0	1	1	Call Forwarding
84	0	0	0	0	0	0	1	0	Call Forwarding
85	0	0	0	0	0	0	1	1	Call Forwarding
86	0	0	0	0	0	0	1	0	Call Forwarding
87	0	0	0	0	0	0	1	1	Call Forwarding
88	0	0	0	0	0	0	1	0	Call Forwarding
89	0	0	0	0	0	0	1	1	Call Forwarding
90	0	0	0	0	0	0	1	0	Call Forwarding
91	0	0	0	0	0	0	1	1	Call Forwarding
92	0	0	0	0	0	0	1	0	Call Forwarding
93	0	0	0	0	0	0	1	1	Call Forwarding
94	0	0	0	0	0	0	1	0	Call Forwarding
95	0	0	0	0	0	0	1	1	Call Forwarding
96	0	0	0	0	0	0	1	0	Call Forwarding
97	0	0	0	0	0	0	1	1	Call Forwarding
98	0	0	0	0	0	0	1	0	Call Forwarding
99	0	0	0	0	0	0	1	1	Call Forwarding
100	0	0	0	0	0	0	1	0	Call Forwarding
101	0	0	0	0	0	0	1	1	Call Forwarding
102	0	0	0	0	0	0	1	0	Call Forwarding
103	0	0	0	0	0	0	1	1	Call Forwarding
104	0	0	0	0	0	0	1	0	Call Forwarding
105	0	0	0	0	0	0	1	1	Call Forwarding
106	0	0	0	0	0	0	1	0	Call Forwarding
107	0	0	0	0	0	0	1	1	Call Forwarding
108	0	0	0	0	0	0	1	0	Call Forwarding
109	0	0	0	0	0	0	1	1	Call Forwarding
110	0	0	0	0	0	0	1	0	Call Forwarding
111	0	0	0	0	0	0	1	1	Call Forwarding
112	0	0	0	0	0	0	1	0	Call Forwarding
113	0	0	0	0	0	0	1	1	Call Forwarding
114	0	0	0	0	0	0	1	0	Call Forwarding
115	0	0	0	0	0	0	1	1	Call Forwarding
116	0	0	0	0	0	0	1	0	Call Forwarding
117	0	0	0	0	0	0	1	1	Call Forwarding
118	0	0	0	0	0	0	1	0	Call Forwarding
119	0	0	0	0	0	0	1	1	Call Forwarding
120	0	0	0	0	0	0	1	0	Call Forwarding
121	0	0	0	0	0	0	1	1	Call Forwarding
122	0	0	0	0	0	0	1	0	Call Forwarding
123	0	0	0	0	0	0	1	1	Call Forwarding
124	0	0	0	0	0	0	1	0	Call Forwarding
125	0	0	0	0	0	0	1	1	Call Forwarding
126	0	0	0	0	0	0	1	0	Call Forwarding
127	0	0	0	0	0	0	1	1	Call Forwarding
128	0	0	0	0	0	0	1	0	Call Forwarding
129	0	0	0	0	0	0	1	1	Call Forwarding
130	0	0	0	0	0	0	1	0	Call Forwarding
131	0	0	0	0	0	0	1	1	Call Forwarding
132	0	0	0	0	0	0	1	0	Call Forwarding
133	0	0	0	0	0	0	1	1	Call Forwarding
134	0	0	0	0	0	0	1	0	Call Forwarding
135	0	0	0	0	0	0	1	1	Call Forwarding
136	0	0	0	0	0	0	1	0	Call Forwarding
137	0	0	0	0	0	0	1	1	Call Forwarding
138	0	0	0	0	0	0	1	0	Call Forwarding
139	0	0	0	0	0	0	1	1	Call Forwarding
140	0	0	0	0	0	0	1	0	Call Forwarding
141	0	0	0	0	0	0	1	1	Call Forwarding
142	0	0	0	0	0	0	1	0	Call Forwarding
143	0	0	0	0	0	0	1	1	Call Forwarding
144	0	0	0	0	0	0	1	0	Call Forwarding
145	0	0	0	0	0	0	1	1	Call Forwarding
146	0	0	0	0	0	0	1	0	Call Forwarding
147	0	0	0	0	0	0	1	1	Call Forwarding
148	0	0	0	0	0	0	1	0	Call Forwarding
149	0	0	0	0	0	0	1	1	Call Forwarding
150	0	0	0	0	0	0	1	0	Call Forwarding
151	0	0	0	0					